

light-tec
be bright. save energy.



LED FLOOD LIGHT

FLOOD LIGHT

ADVANTAGES

- Unique flat wheel form design
- Die-casting integrated AL casing make faster heat dissipation
- Optical glass over 90% light transmitting
- LED 3030 chip with low lumen decay
- IP65 driver with short circuit/over-flow/over-temperature/over-voltage protection
- 150lm/W, over 90% energy saving
- Lifespan 50,000 hours, 36 months warranty from the date of manufacture.
- Easy installation and low maintenance

PRODUCT SIZE

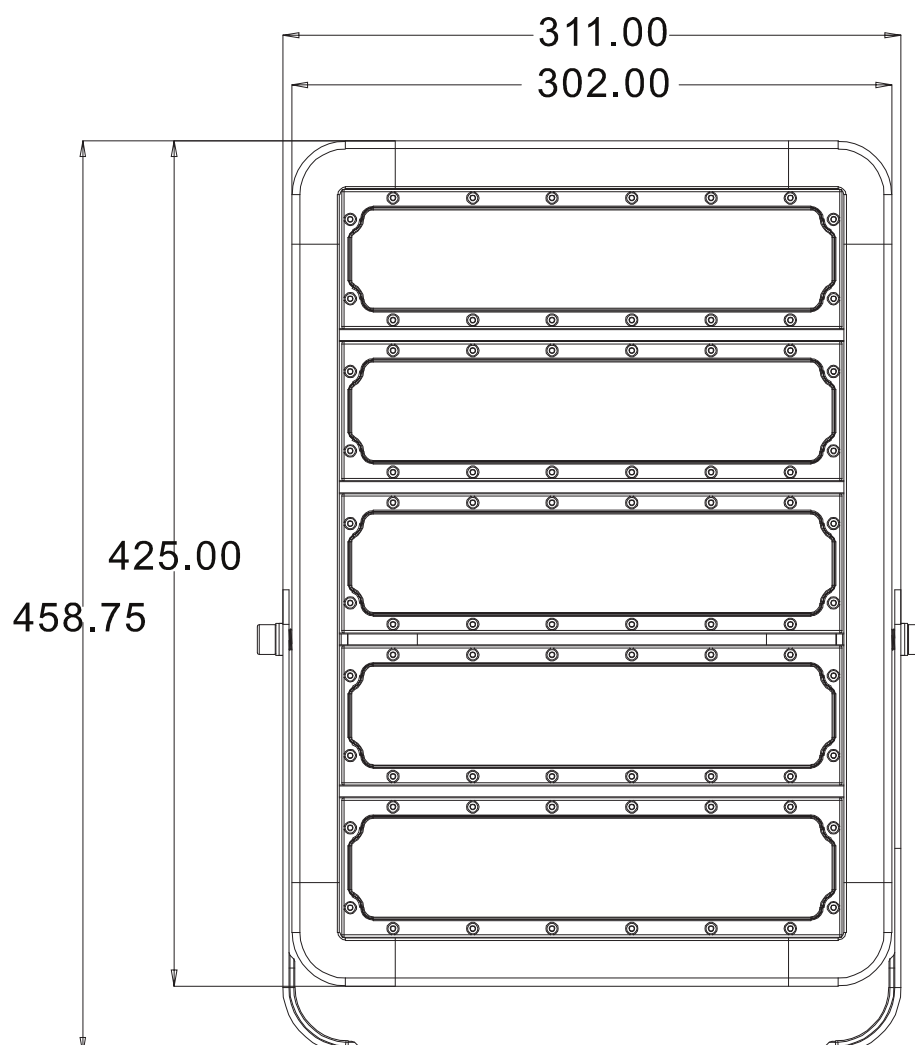

Unit: mm

SPECIFICATIONS

Input voltage	AC100-277V
Power	300W
Dimming	Not
PF	>0.95
LED Type	3030
Beam angle	90!
Light efficiency	150 lm/W
luminous	45000 lm
Color Temp	3000" 200K / 4000" 250K / 5700" 300K / 6500" 500 K
CRI	>70
IP	65
Working Temp	-20!C~45!C
Storage Temp	-40!C~60!C
Life span	50000h@25!C

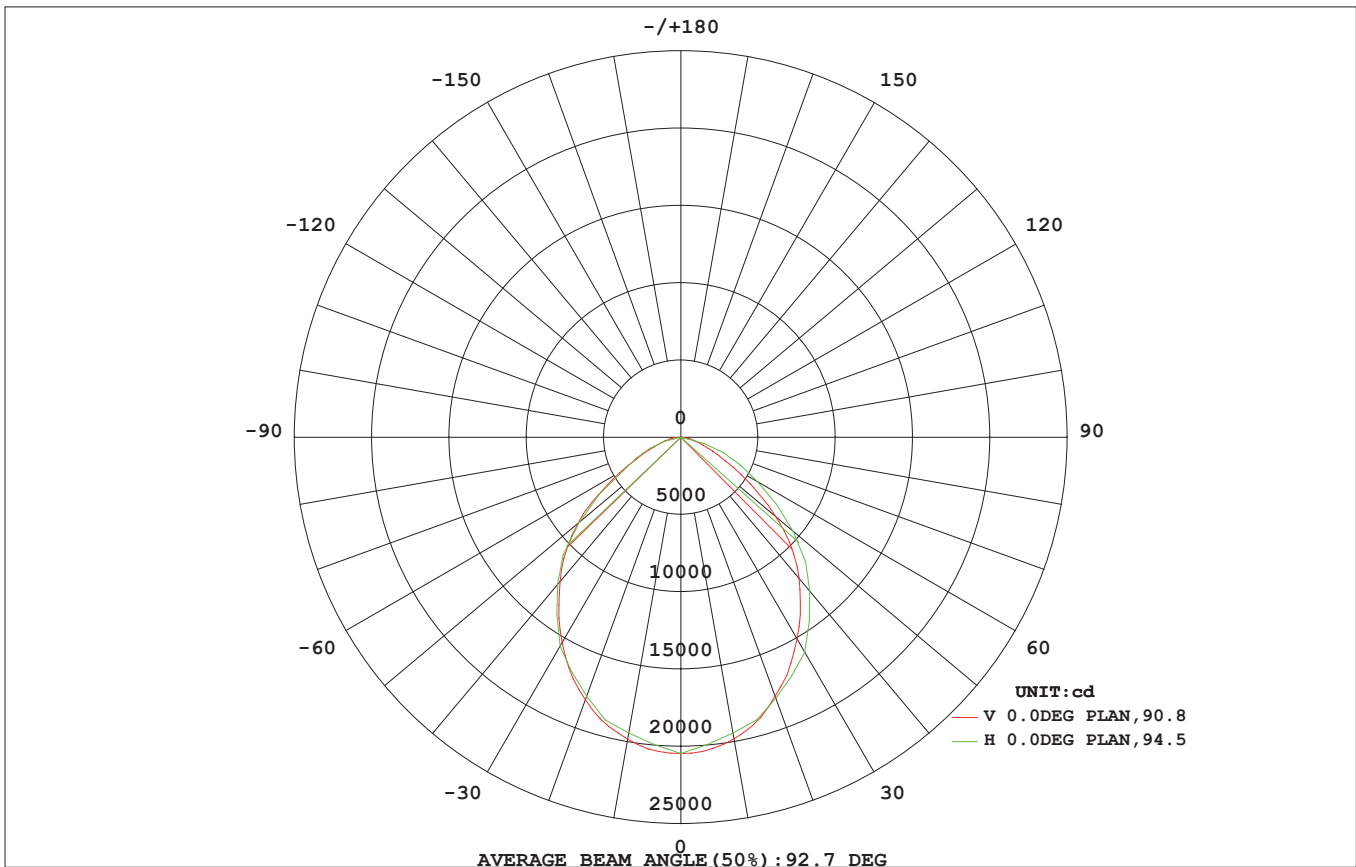

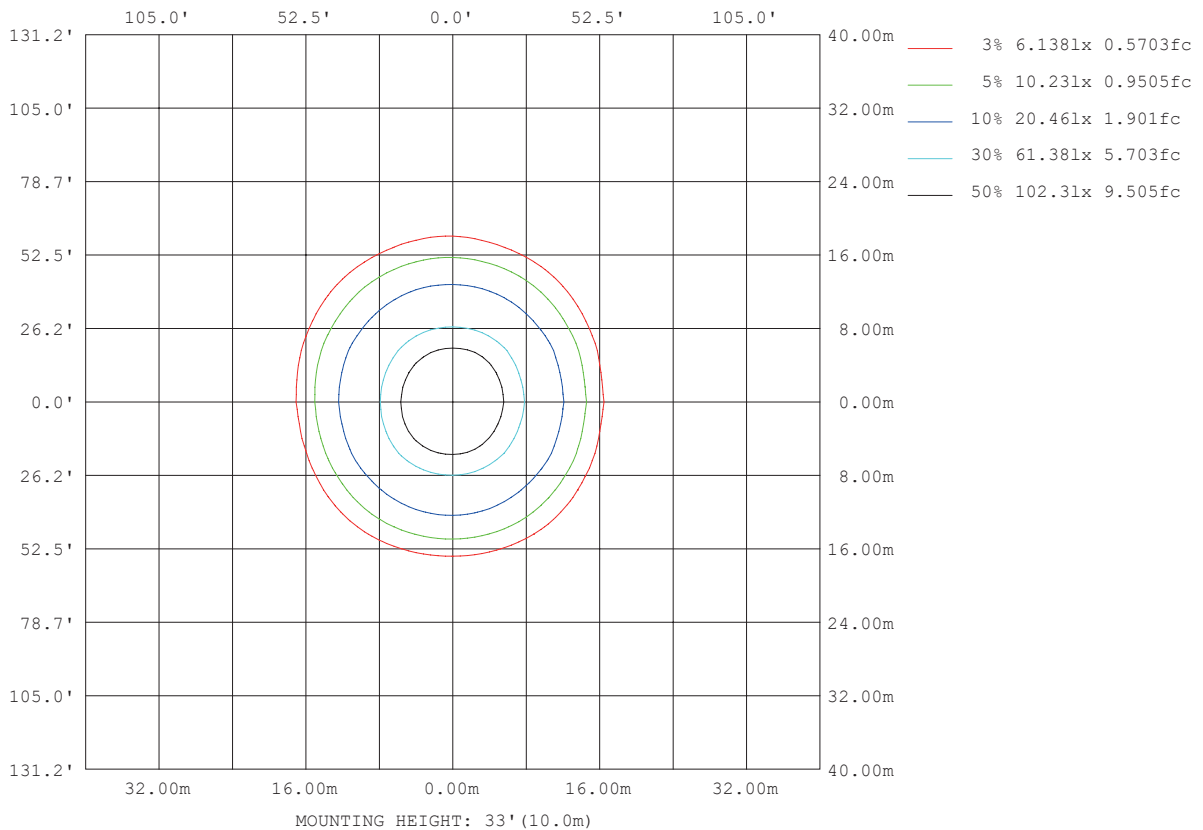
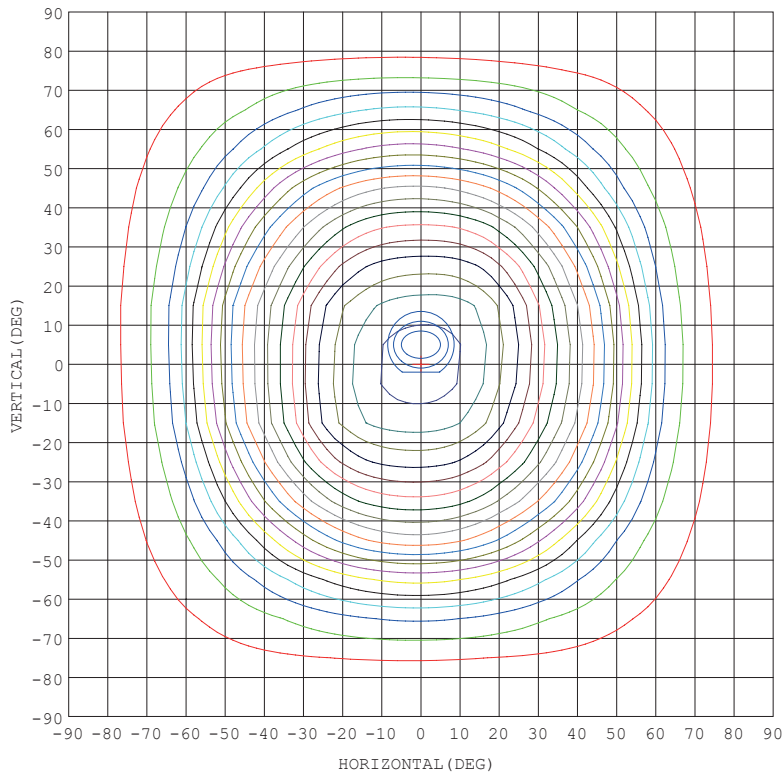

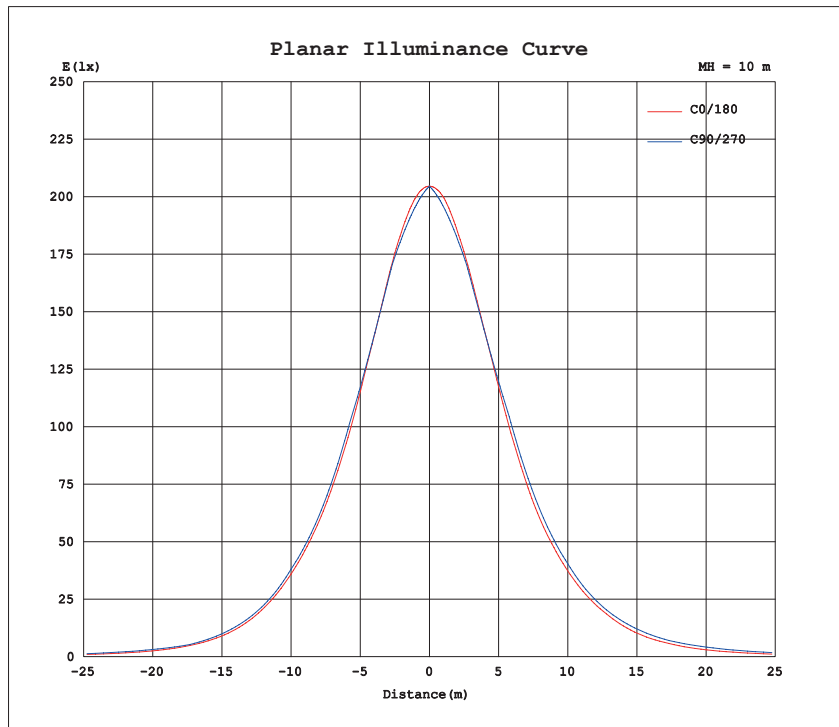

Flux out: 28488 lm

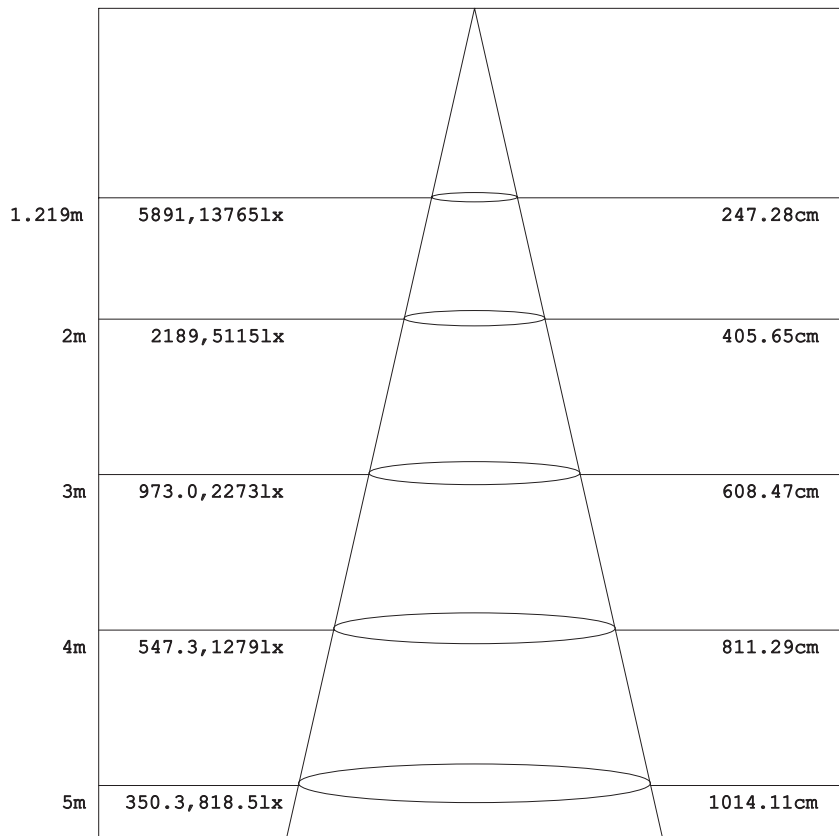

Height Eavg, Emax Angle: 90.80deg Diameter

Note: The Curves indicate the illuminated area and the average illumination when the luminaire is at different distance.

INSTALLATION

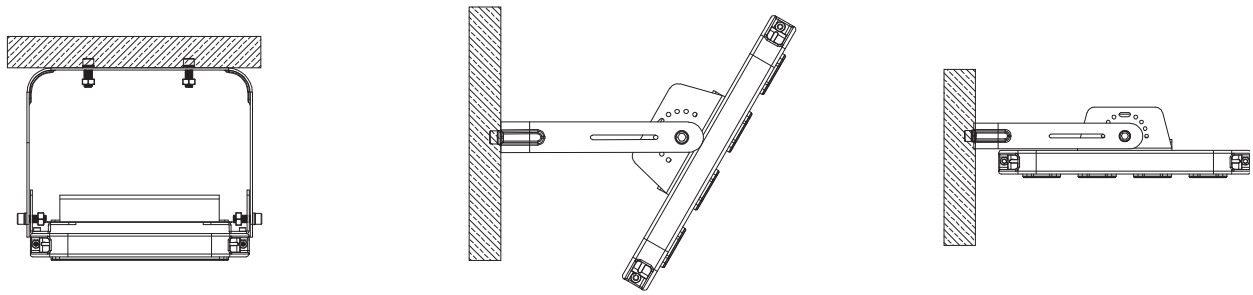

surface mounted

PACKAGE

QTY/Carton	1 pcs
Carton Size	495*350*135mm
N.W	8.8KG
G.W	9.3 KG

CERTIFICATION

